

Window & Louver Catalog 15W

Replacement Wood Sash - Barn & Cellar Sash - Double Hungs - Decorative Louvers - Decorative Windows

Double Hung Windows



Page 2, 5, 6, 9-11

Double Hung Balances



Page 7

Custom Wood Windows

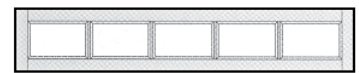

Page 3

Storm Screen Sash

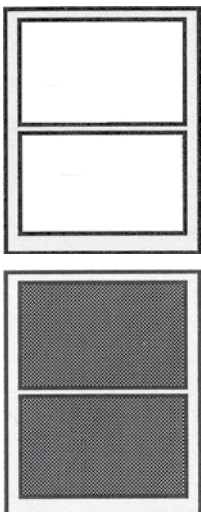

Page 8

Barn-Cellar Sash

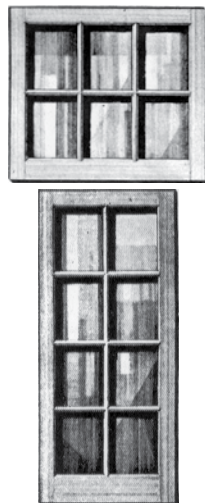

Page 4-5

Decorative Windows

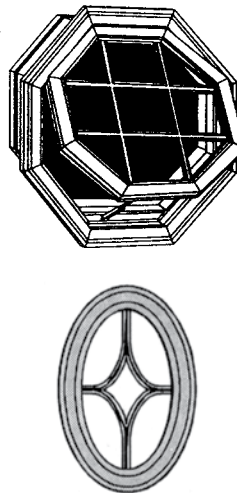

Page 12-13

Decorative Louvers



Page 14-19

Historic Windows

Historic windows are custom designed to meet your specifications. Historic windows can be treated with Wood-Life™ preservative for longevity and durability. Our Historic Windows feature up-to-date methods of weather-stripping with optional insulated glass for maximum efficiency. Historic Windows are available for sash replacement or as complete units. Options include: choice of wood specie, method of sash balance, arch top, oversize windows and hardware. *If you require a historic window but do not need to match custom specifications then request either our Ohio or Lexington™ design.

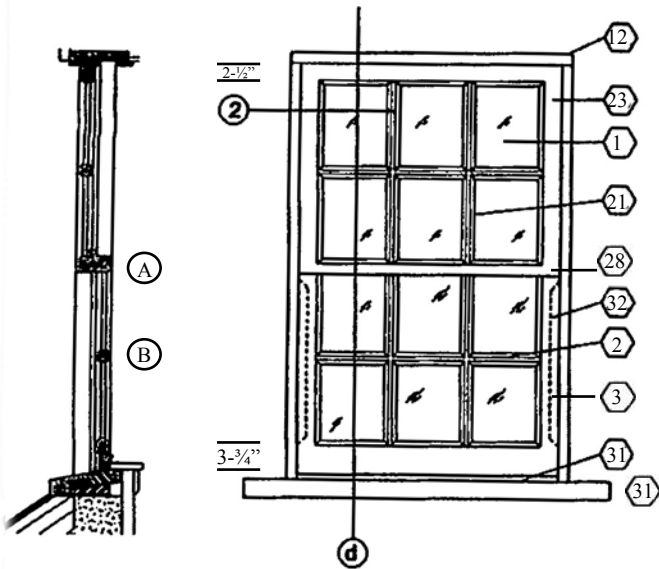

Following are Lexington™ Specifications:

1. Window shown with Insulated glass – True Divided Lights
2. Exterior Stops Sloped Glazed Design
Interior stop design: quarter bead
3. Channel Balancer (Hidden Balancer)
4. Dual seal Insulated Glass
5. PIB Polytecbutylene primary seal
6. Polysulfide Secondary Seal
7. Low E film third surface from Exterior-Optional
8. Hollow Bulb on meeting rail of top sash
9. Glazing channel on all Insulated glass seals
10. Weep channel & weep drain
11. Latch (optional)
12. Frame (sugar pine or equivalent)
14. Desocant & aluminum spacer
15. Stool (Optional) (not pictured)
16. Schagle Pile Insulation (not pictured)
17. Foam filled Bulb on bottom rail of bottom sash
18. Siding (not included)
19. Existing wall assembly (not pictured)
20. Parting Stop
21. Glass bead (clear pine wood species)
22. Muntin (sugar pine or equivalent)
23. Sash (sugar pine or equivalent)
24. Window Stop 1-9/16" (not pictured)
25. Blind Stop (not pictured)
26. Trim board (not included) (not pictured)
28. Meeting (Check) Rails
31. Sill
32. Hidden Balancers
33. Factory primed finish Exterior and Interior (optional)
34. Thumb Lifts: style, quantity, size, finish (Optional)
35. Diagram represents a window with a stile thickness of 1-3/4" with 1/2" glass.

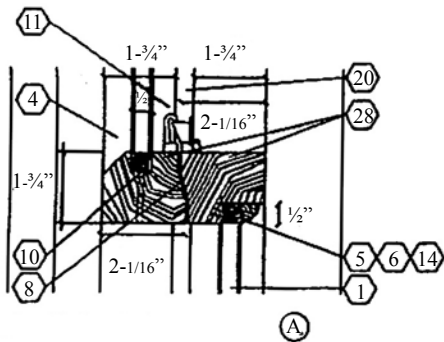

Check (meeting) Rail

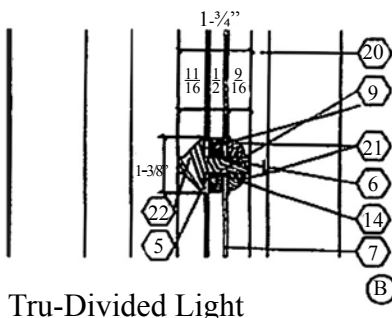

Tru-Divided Light

Custom thick sash of 2-1/4" can be quoted with a maximum glass thickness of 7/8" and a 1/2" stop.

*Historic windows are made to your custom specifications. We can produce a historic window using our Ohio or Lexington™ specifications for a fraction of the cost of a complete custom window. The **Ohio** window is available in 1-3/8" and 1-3/4" thickness. The sash specifications (profile and size of stiles and rails) are set by B&B. We will make the windows to the size you require. The frame and balances can be to your specification. The Lexington™ is a 1-3/4" thick sash with stop glazing that simulates putty glazing. The stile and rail sizes can be altered.

Custom Fixed Wood Sash

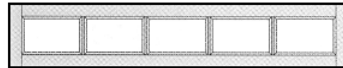

Elliptical Direct Glaze



Segment Transom



Half Round Transom

Custom Fixed sash are available in softwoods and hardwoods.

Glass Options: Single strength (SSB), Double strength (DSB), 1/4", Insulated, Tempered and decorative patterns (see store.bbwood.com).

Specifications: We offer a pine putty glazed sash in 1-3/8" and 1-3/4" thickness. For stop glazed units we offer veneered stiles and rails in softwood and hardwood. Stop glazed units can be quoted. in 1-3/8", 1-3/4" and 2-1/4" thickness.

Light patterns are TDL (tru-divided lights) in rectangular patterns. Curved light designs may be quoted as SDL (simulated divided lights).

Radius tops in half round, segment or elliptical.

All sash can be supplied with interior jambs or exterior frames.
Direct glazed (no sash) jambs/frames can be quoted.

B&B Wood Products inc.

Barn Sash

1-1/16" Thick , Paint Grade

Specifications:

- Glazed Single Strength (SS) non-tempered clear.
- Western softwoods finger-jointed paint grade
- Water Repellent Preservation Treated
- Glass set in Bedding Compound
- Pressed (Groove) Glazed. Not reglazable.

	Layout
Top Rail	1-5/8"
Bottom Rail	2-1/16"
Stiles	1-25/32"
Thickness	1-1/16"

Dimensions are nominal.

Note: Drawings are not to scale



4-Lite

Glass Size	Overall WxH
8 x 10	20-1/8" x 25"
8 x 12	20-1/8" x 29"
9 x 12	22-1/8" x 29"
9 x 14	22-1/8" x 33"
10 x 12	24-1/8" x 29"
10 x 14	24-1/8" x 33"

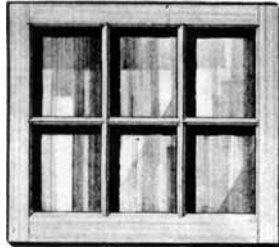

6 Lt. (3W 2H)

Glass Size	Overall WxH
8 x 10	28-13/16" x 25"
8 x 12	28-13/16" x 29"
9 x 12	31-13/16" x 29"
10 x 12	34-13/16" x 29"

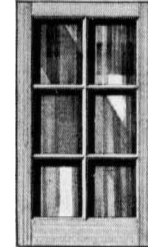

6 Lt. (2W 3H)

Glass Size	Overall WxH
8 x 10	20-1/8" x 35-1/4"
9 x 12	22-1/8" x 41-1/4"
10 x 12	24-1/8" x 41-1/4"



8-Lite

Glass Size	Overall WxH
8 x 10	20-1/16" x 46-9/16"



9-Lite

Glass Size	Overall WxH
8 x 10	28-13/16" x 35-13/16"
9 x 12	31 13/16" x 41-13/16"
10 x 12	34 13/16" x 41-13/16"

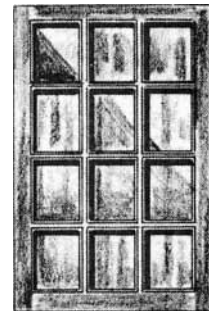

12-Lite

Glass Size	Overall WxH
8 x 10	28-13/16" x 46-13/16"
9 x 12	31-13/16" x 54-13/16"

B&B Wood Products inc.

Cellar Sash

1-3/8" Thick , Clear Pine

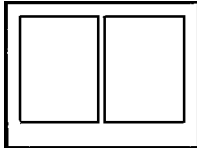

TWO-LIGHT

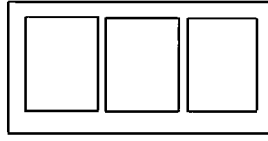

THREE-LIGHT

Glass Size	Pattern	Overall Size
12 x 12	2 Light	28-5/16" x 17-3/16"
12 x 16	2 Light	28-5/16" x 21-3/16"
8 x 8	3 Light	28-5/16" x 13-3/16"
8 x 10	3 Light	28-5/16" x 15-3/16"
8 x 12	3 Light	28-5/16" x 17-3/16"
8 x 14	3 Light	28-5/16" x 19-3/16"
8 x 16	3 Light	28-5/16" x 21-3/16"
9 x 12	3 Light	31-5/16" x 17-3/16"
9 x 14	3 Light	31-5/16" x 19-3/16"
9 x 16	3 Light	31-5/16" x 21-3/16"
9 x 18	3 Light	31-5/16" x 23-3/16"
10 x 12	3 Light	34-5/16" x 17-3/16"
10 x 14	3 Light	34-5/16" x 19-3/16"
10 x 16	3 Light	34-5/16" x 21-3/16"
10 x 18	3 Light	34-5/16" x 23-3/16"
12 x 16	3 Light	40-5/16" x 21-3/16"

Casement Sash

1-3/8" Thick , Clear Pine

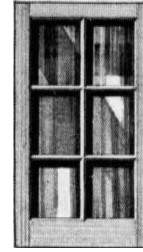

6-LIGHT



8-LIGHT

Glass Size	Pattern	Overall Size
8 x 10	6 Light	20-9/16" x 35-3/16"
8 x 12	6 Light	20-9/16" x 41-3/16"
10 x 10	6 Light	24-9/16" x 35-3/16"
10 x 12	6 Light	24-9/16" x 41-3/16"
8 x 10	8 Light	20-9/16" x 45-3/16"
8 x 12	8 Light	20-9/16" x 53-3/16"
10 x 10	8 Light	24-9/16" x 45-3/16"
10 x 12	8 Light	24-9/16" x 53-3/16"

Rabbeting in Pairs: Option

Double-Hung Replacement Sash - Ohio Layout

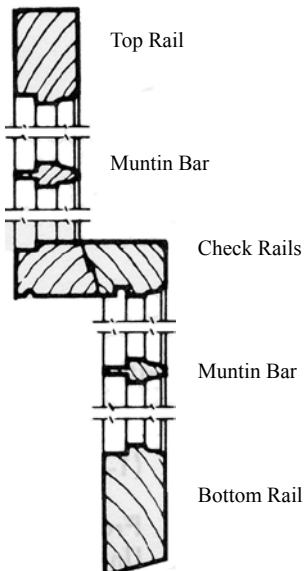

See next page for standard sizes

Specifications:

- Glazed Single Pane (SS) non-tempered clear
- Construction: Clear Pine - Open mortise and tenon
- Water Repellent Preservation Treated
- Glass set in Bedding Compound
- Putty Glazed
- Plowed for weights and cords
- Available 1-3/8" or 1-3/4" thick

Sash Opening Sizes:

Top Sash: Width= Glass + 4-5/16"; Height= Glass + 3-1/4"

Bot Sash: Width= Glass + 4-5/16"; Height= Glass + 4-1/8"

Fixed Sash: Width= Glass + 4-5/16"; Height= Glass + 5-3/16" (Beveled bottom rail)

Double Hung: Width= Glass + 4-5/16"; Height= 2 x Glass + 6-3/16"

	OA Size
Stiles & Top Rail	2-5/16"
Bottom Rail	3-3/16"
Check Rails	1-1/4"
Muntin* (1/4" between glass)	5/8"

*wider muntins are available
Dimensions are nominal.



OHIO WINDOW SASH

Clear unfinished pine 1-3/8" thick Check Rail Windows, WoodLife (water-repellant) treated. Plowed for Weights and Cords (wc*). Bottom rail beveled 14°. Sash are not weatherstripped. Putty glazed single strength glass (SSB) with stop glazed insulated option.

Sash Sizes:

Top Sash: Width= Glass + 4-5/16"; Height= Glass + 3-1/4"

Bot Sash: Width= Glass + 4-5/16"; Height= Glass + 4-1/8"

Fixed Sash: Width= Glass + 4-5/16"; Height= Glass + 5-3/16" (Beveled bot rail)

GLASS SIZES	SASH OPENING
16X14	1'8½" x 2'10"
16X16	1'8½" x 3'2"
16X18	1'8½" x 3'6"
16X20	1'8½" x 3'10"
16X22	1'8½" x 4'2"
16X24	1'8½" x 4'6"
16X26	1'8½" x 4'10"
16X28	1'8½" x 5'2"
16X30	1'8½" x 5'6"
16X32	1'8½" x 5'10"
18X14	1'10½" x 2'10"
18X16	1'10½" x 3'2"
18X18	1'10½" x 3'6"
18X20	1'10½" x 3'10"
18X22	1'10½" x 4'2"
18X24	1'10½" x 4'6"
18X26	1'10½" x 4'10"
18X28	1'10½" x 5'2"
18X30	1'10½" x 5'6"
18X32	1'10½" x 5'10"
20X12	2'0½" x 2'6"
20X14	2'0½" x 2'10"
20X16	2'0½" x 3'2"
20X18	2'0½" x 3'6"
20X20	2'0½" x 3'10"
20X22	2'0½" x 4'2"
20X24	2'0½" x 4'6"
20X26	2'0½" x 4'10"
20X28	2'0½" x 5'2"
20X30	2'0½" x 5'6"
20X32	2'0½" x 5'10"
20X34	2'0½" x 6'2"
20X36	2'0½" x 6'6"

GLASS SIZES	SASH OPENING
22X14	2'2½" x 2'10"
22X16	2'2½" x 3'2"
22X18	2'2½" x 3'6"
22X20	2'2½" x 3'10"
22X22	2'2½" x 4'2"
22X24	2'2½" x 4'6"
22X26	2'2½" x 4'10"
22X28	2'2½" x 5'2"
22X30	2'2½" x 5'6"
22X32	2'2½" x 5'10"
24X12	2'4½" x 2'6"
24X14	2'4½" x 2'10"
24X16	2'4½" x 3'2"
24X18	2'4½" x 3'6"
24X20	2'4½" x 3'10"
24X22	2'4½" x 4'2"
24X24	2'4½" x 4'6"
24X26	2'4½" x 4'10"
24X28	2'4½" x 5'2"
24X30	2'4½" x 5'6"
24X32	2'4½" x 5'10"
24X34	2'4½" x 6'2"
24X36	2'4½" x 6'6"
24X38	2'4½" x 6'10"
24X40	2'4½" x 7'2"
26X12	2'6½" x 2'6"
26X14	2'5½" x 2'10"
26X16	2'6½" x 3'2"
26X18	2'6½" x 3'6"
26X20	2'6½" x 3'10"
26X22	2'6½" x 4'2"
26X24	2'6½" x 4'6"

GLASS SIZES	SASH OPENING
26X26	2'6½" x 4'10"
26X28	2'6½" x 5'2"
26X30	2'6½" x 5'6"
26X32	2'6½" x 5'10"
26X34	2'6½" x 6'2"
26X36	2'6½" x 6'6"
26X38	2'6½" x 6'10"
26X40	2'6½" x 7'2"
27X14	2'7½" x 2'10"
27X16	2'7½" x 3'2"
27X18	2'7½" x 3'6"
27X20	2'7½" x 3'10"
27X22	2'7½" x 4'2"
27X24	2'7½" x 4'6"
27X26	2'7½" x 4'10"
27X28	2'7½" x 5'2"
27X30	2'7½" x 5'6"
27X32	2'7½" x 5'10"
27X34	2'7½" x 6'2"
27X36	2'7½" x 6'6"
28X12	2'8½" x 2'6"
28X14	2'8½" x 2'10"
28X16	2'8½" x 3'2"
28X18	2'8½" x 3'6"
28X20	2'8½" x 3'10"
28X22	2'8½" x 4'2"
28X24	2'8½" x 4'6"
28X26	2'8½" x 4'10"
28X28	2'8½" x 5'2"
28X30	2'8½" x 5'6"
28X32	2'8½" x 5'10"
28X34	2'8½" x 6'2"
28X36	2'8½" x 6'6"
30X16	2'10½" x 3'2"
30X18	2'10½" x 3'6"
30X20	2'10½" x 3'10"
30X22	2'10½" x 4'2"
30X24	2'10½" x 4'6"
30X26	2'10½" x 4'10"
30X28	2'10½" x 5'2"
30X30	2'10½" x 5'6"
30X32	2'10½" x 5'10"
30X34	2'10½" x 6'2"
30X36	2'10½" x 6'6"
32X16	3'0½" x 3'2"
32X18	3'0½" x 3'6"
32X20	3'0½" x 3'10"

GLASS SIZES	SASH OPENING
32X22	3'0½" x 4'2"
32X24	3'0½" x 4'6"
32X26	3'0½" x 4'10"
32X28	3'0½" x 5'2"
32X30	3'0½" x 5'6"
32X32	3'0½" x 5'10"
32X34	3'0½" x 6'2"
32X36	3'0½" x 6'6"
34X16	3'2½" x 3'2"
34X18	3'2½" x 3'6"
34X20	3'2½" x 3'10"
34X22	3'2½" x 4'2"
34X24	3'2½" x 4'6"
34X26	3'2½" x 4'10"
34X28	3'2½" x 5'2"
34X30	3'2½" x 5'6"
34X32	3'2½" x 5'10"
34X34	3'2½" x 6'2"
34X36	3'2½" x 6'6"
36X16	3'4½" x 3'2"
36X18	3'4½" x 3'6"
36X20	3'4½" x 3'10"
36X22	3'4½" x 4'2"
36X24	3'4½" x 4'6"
36X26	3'4½" x 4'10"
36X28	3'4½" x 5'2"
36X30	3'4½" x 5'6"
36X32	3'4½" x 5'10"
36X34	3'4½" x 6'2"
36X36	3'4½" x 6'6"
38X20	3'6½" x 3'10"
38X22	3'6½" x 4'2"
38X24	3'6½" x 4'6"
38X26	3'6½" x 4'10"
38X28	3'6½" x 5'2"
38X30	3'6½" x 5'6"
38X32	3'6½" x 5'10"
38X34	3'6½" x 6'2"
38X36	3'6½" x 6'6"
40X20	3'8½" x 3'10"
40X22	3'8½" x 4'2"
40X24	3'8½" x 4'6"
40X26	3'8½" x 4'10"
40X28	3'8½" x 5'2"
40X30	3'8½" x 5'6"
40X32	3'8½" x 5'10"
40X34	3'8½" x 6'2"
40X36	3'8½" x 6'6"

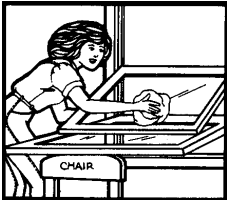

Vinyl Tilt Sash Balances

Glass Height	Sash Opening
12"	2'6"
14"	2'10"
16"	3'2"
18"	3'6"
20"	3'10"
22"	4'2"
24"	4'6"
26"	4'10"
28"	5'2"
30"	5'6"
24/36"	5'6"
32"	5'10"
34"	6'2"
36"	6'6"

Special Order - Allow 2 Weeks

Replacement balances are of rigid PVC construction with flex-leaf open construction. Springs are concealed and protected. Spring noise is eliminated with a sound deadener attached to each spring.

Advanced foam with a closed cell edge is standard on the back of each balance. The foam acts as a compression spring with the closed cell edge providing a superior air and water seal. Balances will support each sash weighing up to 22lbs.

Note: balance systems are subject to change as technology improves.

PREPARING THE SASH

1. Make sash width 1-1/2" under frame opening.
2. Plow stiles at their centers. 5/8" wide by 3/16" deep.

Spirex Sash Balances

Fits groove, round or square, 5/8" x 5/8".

Glass Height	Window Openings Height	Balance Top Sash	Balance Bottom Sash	Stock Red Balance
12"	2'6"	SP-15	SP-13	4-14 lbs
14"	2'10"	SP-17	SP-15	4-14
16"	3'2"	SP-19	SP-17	4-14
18"	3'6"	SP-21	SP-19	4-15
20"	3'10"	SP-23	SP-21	4-16 lbs.
22"	4'2"	SP-25	SP-23	4-16
24"	4'6"	SP-27	SP-25	4-18
26"	4'10"	SP-29	SP-27	4-18
28"	5'2"	SP-31	SP-29	4-18
30"	5'6"	SP-33	SP-31	4-18
32"	5'10"	SP-35	SP-33	8-26
34"	6'2"	SP-37	SP-35	8-26 lbs.
36"	6'6"	SP-39	SP-37	8-26
38"	6'10"	SP-41	SP-39	8-26 lbs.
40"	7'2"	SP-43	SP-41	8-26

Spirex does not include nails or screws.

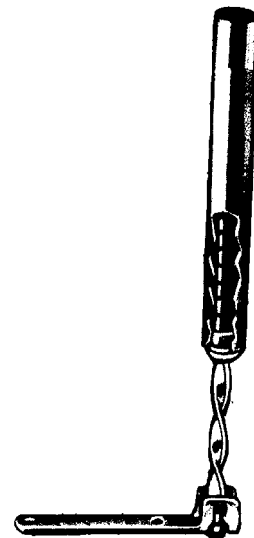

Window Weatherstrip

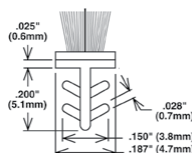

K56 is a gray polypropylene pile brushseal with a flexible center fin, bonded to a two-component plastic base. It fits a 1/8" x 1/4" (3mm x 6mm) groove and is ideal for sliding and double-hung windows where the gap between the window face and the stop is constant.

Two Light Wood Storm & Screen Panels

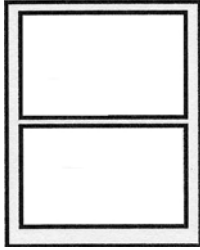

Storm Panel

Storm Specifications:

- Glazed Double Strength (DS) non-tempered clear.
- Clear Pine
- Water Repellent Preservation Treated
- Stop Glazed

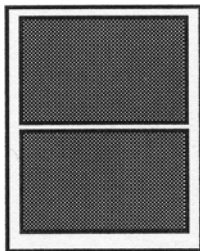

Screen Panel

Screen Specifications:

- Charcoal aluminum screening standard
Fiberglass or bright aluminum are available.
- Clear Pine
- Water Repellent Preservation Treated
- Stop Glazed

Sizes: Width: Visible Glass + 4-1/2"; Height: 2 x Visible Glass + 6-3/4"

Storm & Screen	Overall
Top Rail & Stiles	2-1/4"
Bottom Rail	3-1/4"
Center Rail	1-1/2"
Thick	1-1/8"

When ordering please specify the overall width by the overall height.

Example: a 24 x 24 double hung window would typically have a storm sash size of 28-1/2" x 54-3/4".

Screen & Storm Sash Hardware - Priced in Hardware Section



V83

Galvanized 1-3/4"
Sold 4 per Carton



V80

Galvanized
Sold Per Pair

Wood-Tilt* Double Hung Units

Featuring Tru-Divided Glass Pane Option

Wood-Tilt windows, 1-3/8" thick, are custom manufactured by B&B Wood Products. Top and bottom sash are clear kiln-dried treated Pine. Frames are treated and primed. To prevent rotting the sill and brickmould (WM180) are primed composite. Units are available putty glazed single pane or stop glazed insulated glass. Sash lock and lift are additional. Wood Tilt Units can be quoted with 1-3/4" thick sash and concealed non-tilt balances.

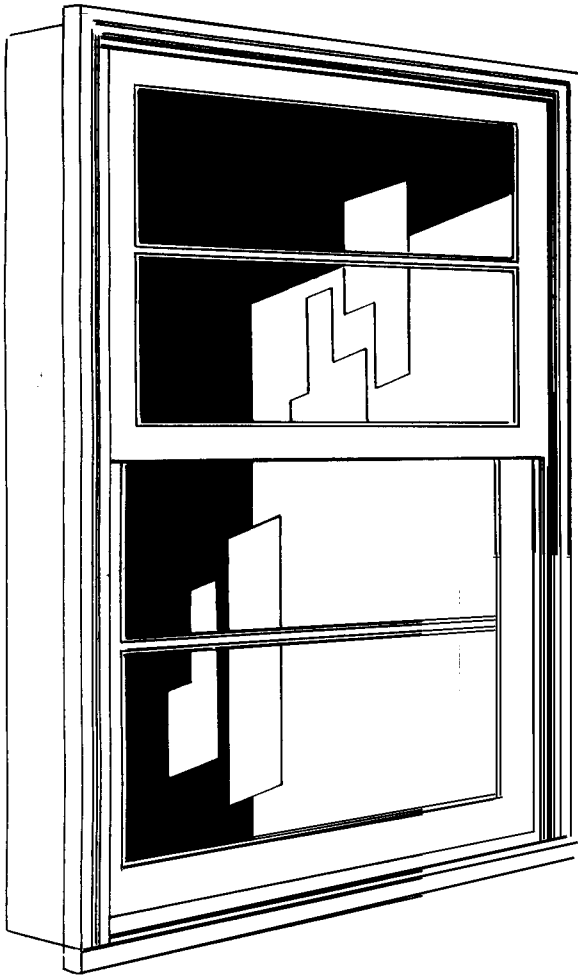

*Concealed Balance System

The concealed balances are an excellent option for historic window renovations, eliminating exposed hardware and maintaining the original window appearance. Concealed balance units do not tilt.

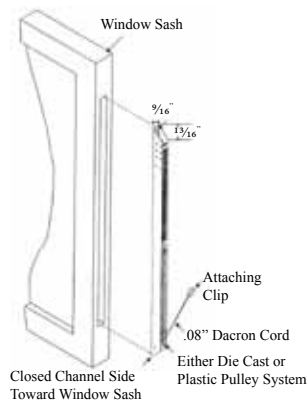

WEATHERSTRIPPED

Flexible weatherstrip on head parting stop and on all horizontal sash parts. PLUS the action of the vinyl tracks makes **Wood-Tilt** window units weather tight.

ASSEMBLED
Wood-Tilt
DOUBLE HUNG

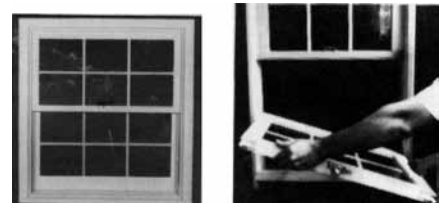

A pull inwards and your **Wood-Tilt** sash tilts into your room! Wash or paint them whenever it is convenient, then simply snap them back! Wood-Tilt windows are trouble-free. The balances are of rigid PVC construction with flex-leaf open construction. The sash is held in place solidly yet the individual leaves will move out of the way to allow for tilting. Spring noise is eliminated with a sound deadener attached to each spring.

Advanced foam with a closed cell edge is standard on the back of each balance. The foam acts as a compression spring with the closed cell edge providing a superior air and water seal. Flexible weather strip on all horizontal parts.

Wood-Tilt Window Extras

Wood Seal/Tilt Upgrades	Details
Concealed Balances	Non-Tilt
Mulled Units	Twins Triples Quads
Spread Mull	Up to 5-1/2"
Long Sill Horns (no casing)	Up to 5-1/2" each sill horn
Jamb Size - Poplar extention jamb added to interior	4-11/16" to 5-1/4" 5-3/8" to 7-1/4"
Flat Casing - 1" thick	Up to 2-5/8" Up to 3-1/2" Up to 5-1/2"
Tru-Divided Lights (for SSB units)	Rectangular Lights (1/4" btwn glass)
Muntin Bar: (wood bar that divides glass)	Upgrade to 3/8" between glass
Oriel Windows	Top glass 24" ; bottom glass 36"
Obscure (#62) Glass	

FRAME DETAILS

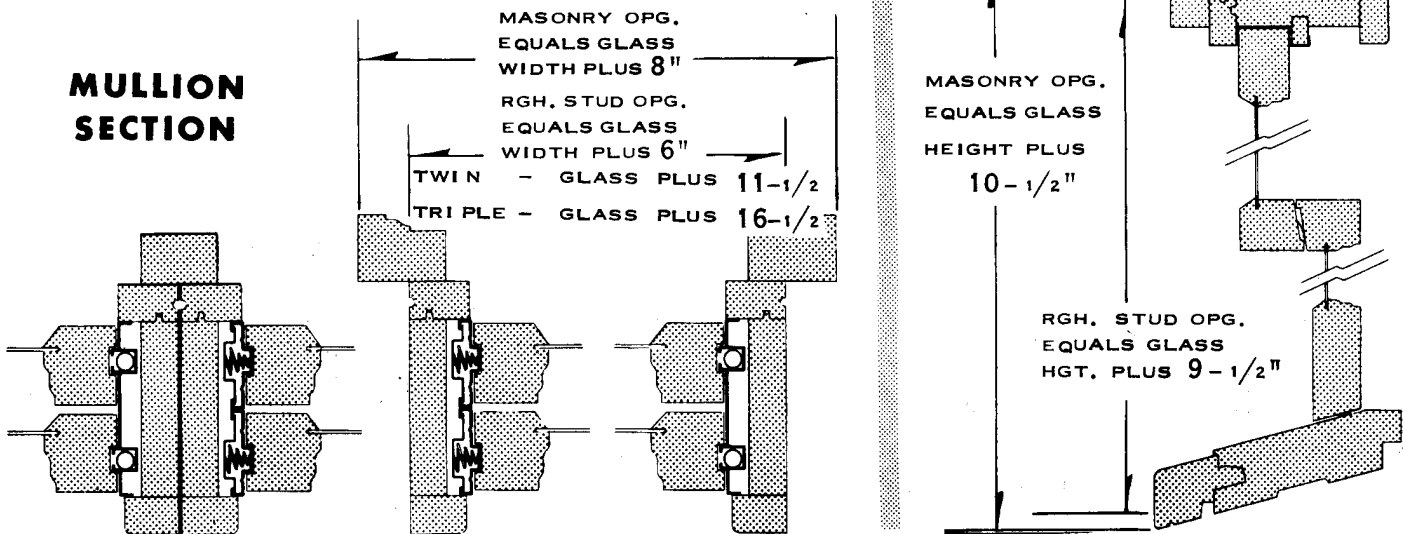

B&B Wood Products inc.

ASSEMBLED

Wood-Tilt

DOUBLE HUNG

Includes - 1-3/8" thick sash.
 Vinyl Tilt balances and brick mould.
 Units are fully weather-stripped.
 Sash lock and sash lift are NOT included.
 Special Order and not returnable.

SPECIFY WHEN ORDERING

1. Jamb Width
2. Brickmould or Flat Casing
3. Equal sash or cottage windows
4. Glass Light Pattern
5. Insulated or Single Pane glass (SSB)

We can manufacture a window to fit your opening. Below are a few sizes as an example.

Glass Size	Rough Opening
12 x 16	1'6"x 3'5½"
12 x 18	1'6"x 3'9½"
12 x 20	1'6"x 4'1½"
12 x 22	1'6"x 4'5½"
12 x 24	1'6"x 4'9½"
16 x 16	1'10"x 3'5½"
16 x 18	1'10"x 3'9½"
16 x 20	1'10"x 4'1½"
16 x 22	1'10"x 4'5½"
16 x 24	1'10"x 4'9½"
16 x 26	1'10"x 5'1½"
16 x 28	1'10"x 5'5½"
16 x 30	1'10"x 5'9½"
20 x 14	2'2"x 3'1½"
20 x 16	2'2"x 3'5½"
20 x 18	2'2"x 3'9½"
20 x 20	2'2"x 4'1½"
20 x 22	2'2"x 4'5½"
20 x 24	2'2"x 4'9½"
20 x 26	2'2"x 5'1½"
20 x 28	2'2"x 5'5½"
20 x 30	2'2"x 5'9½"
24 x 12	2'6"x 2'9½"
24 x 14	2'6"x 3'1½"
24 x 16	2'6"x 3'5½"
24 x 18	2'6"x 3'9½"
24 x 20	2'6"x 4'1½"
24 x 22	2'6"x 4'5½"
24 x 24	2'6"x 4'9½"
24 x 26	2'6"x 5'1½"
24 x 28	2'6"x 5'5½"
24 x 30	2'6"x 5'9½"
28 x 16	2'10"x 3'5½"
28 x 18	2'10"x 3'9½"
28 x 20	2'10"x 4'1½"
28 x 22	2'10"x 4'5½"

Glass Size	Rough Opening
28 x 24	2'10"x 4'9½"
28 x 26	2'10"x 5'1½"
28 x 28	2'10"x 5'5½"
28 x 30	2'10"x 5'9½"
32 x 16	3'2"x 3'5½"
32 x 18	3'2"x 3'9½"
32 x 20	3'2"x 4'1½"
32 x 22	3'2"x 4'5½"
32 x 24	3'2"x 4'9½"
32 x 26	3'2"x 5'1½"
32 x 28	3'2"x 5'5½"
32 x 30	3'2"x 5'9½"
36 x 16	3'6"x 3'5½"
36 x 18	3'6"x 3'9½"
36 x 20	3'6"x 4'1½"
36 x 22	3'6"x 4'5½"
36 x 24	3'6"x 4'9½"
36 x 26	3'6"x 5'1½"
36 x 28	3'6"x 5'5½"
36 x 30	3'6"x 5'9½"
40 x 20	3'10"x 4'1½"
40 x 22	3'10"x 4'5½"
40 x 24	3'10"x 4'9½"
40 x 26	3'10"x 5'1½"
40 x 28	3'10"x 5'5½"
40 x 30	3'10"x 5'9½"
44 x 20	4'2"x 4'1½"
44 x 22	4'2"x 4'5½"
44 x 24	4'2"x 4'9½"
44 x 26	4'2"x 5'1½"
44 x 28	4'2"x 5'5½"
44 x 30	4'2"x 5'9½"
48 x 20	4'6"x 4'1½"
48 x 22	4'6"x 4'5½"
48 x 24	4'6"x 4'9½"
48 x 28	4'6"x 5'5½"
48 x 30	4'6"x 5'9½"

Oval Windows - **Molded or Wood



**The molded Oval window has a traditional brick mould profile, a one-piece molded polyurethane exterior, and a natural laminated Pine interior. The high-density polyurethane exterior is weather resistant and features an integrated nail fin for easy installation.

OVW 1-Light

OVW 6-Light

Model	Rough Opening	Jamb	Prime Exterior	**Molded Exterior
			Insul Glass	Insul Glass
OVW1420 1-Light	1'6" x 2'2"	4-9/16"	Item # 78522	Item # -
OVW1420 6-Light+	1'6" x 2'2"	4-9/16"	Item # 78529	Item # -
OVW1828 1-Light	1'10" x 2'10"	4-9/16"	Item # 88530	Item # 43892
OVW1828 6-Light+	1'10" x 2'10"	4-9/16"	Item # 78447	Item # 43772
OVW24310 6-Light+	2'6" x 4'0"	4-9/16"	Item # 78448	Item # -
OVW21048 6-Light+	3'0" x 4'10"	4-9/16"	Item # 78449	Item # -

For outside of Brickmould to outside of Brickmould add 2". +These units have a removable grid on the interior

Octagon Windows - Exterior: Wood or Clad

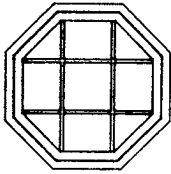

OW

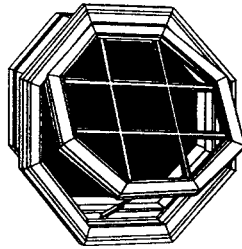

OWV

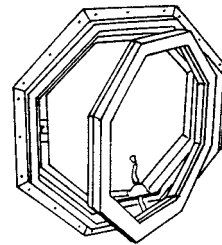

OPOCTW25

		*Wood Exterior		White Vinyl Clad Exterior	
		Single (DSB) Glass	Insul Glass	Insul Glass	
	RO Wood	Item #	Item #	RO Clad	Item #
OW 1-8 1-Light	1'9-1/2"	-	81915	1'9-1/2"	85907
OW 1-8 9-Light+	1'9-1/2"	81917	81913	1'9-1/2"	85906
OW 1-8 9-Light GBG	1'9-1/2"	-	-	1'9-1/2"	01893
OW 2-0 1-Light	2'2"	-	-	2'0-5/8"	78737
OW 2-0 9-Light+	2'2"	-	00151	2'0-5/8"	78741
OW 2-6 9-Light+	-	-	-	2'6-1/2"	86014
OW 2-8 9-Light+	2'10"	00132	43752	-	-
OW 3-0 1-Light	3'2"	-	85376	-	-
OW 3-0 9-Light+	3'2"	-	78437	3'0-1/2"	78743
OPERATING - includes screen & grid		*Wood Exterior		White Clad Exterior (COWV)	
OWV 1-11 9-Light+	2'0-1/2"	-	77610	2'0-1/2"	77695
OWV 1-11 9-Lt GBG	2'0-1/2"	-	-	2'0-1/2"	77721
OPOCTW25 1-Light	-	-	-	2'1-1/2	OPOCTW25
OWV 2-5 9-Light+	2'7"	-	-	-	-
OWV 2-11 9-Light+	3'1"	-	-	-	-

*Wood exterior units may be natural or primed at B&B option. Clad colors: White, Earth, Sand, Bronze

Pine Casings, Grids and Extension Jamb sold separately

OWV units have push bar operator that telescopes to 2 open positions. Screen is almond.

OPOCTW25 exterior is PVC. Hinged Right as pictured. Custom Left (LH) per quote.

Round Windows - Exterior: **Molded or Wood

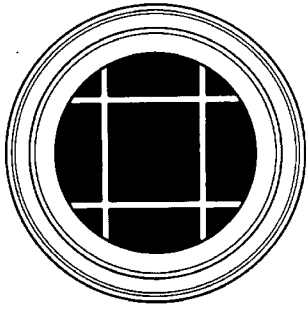

RW 9-Light
Fixed

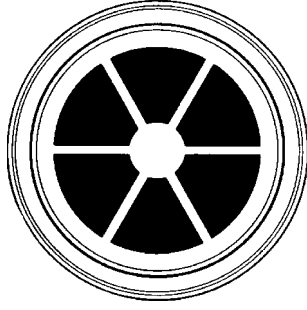

RW 6-Light
Fixed

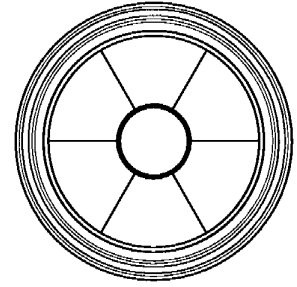

RWMLD 3-0 7-LT
Fixed

4-9/16" Jamb. +Prices include interior removable grid

Call for pricing on Prefinished Exterior.
All units have pine unfinished Interior

FIXED	Rough Opening	Prime Wood Exterior		**Molded Exterior
		Single (SSB) Glass	Insul Glass	Insul Glass
		Item #	Item #	Item #
RW 1-6 1-light	1'8"	-	86133	-
RW 1-6 6-light +	1'8"	86029	86055	-
RW 1-6 9-light +	1'8"	86030	-	-
RW 2-0 1-light	2'2"	-	86069	43884
RW 2-0 6-light +	2'2"	-	86057	43609
RW 2-0 9-light +	2'2"	86039	86058	26423
RW 3-0 1-light	3'2"	-	-	43890
RW 3-0 6-light +	3'2"	-	78451	43842
RW 3-0 9-light +	3'2"	80396	78450	43799
RWMLD 3-0 7-LT+	3'2"	-	-	43807

For outside of Brickmould to outside of Brickmould add 2"

**The molded Round window has a traditional brick mould profile, a one-piece molded polyurethane exterior, and a natural laminated Pine interior. The high-density polyurethane exterior is weather resistant and features an integrated nail fin for easy installation.

Pine Casings



WM324
11/16 X 2-1/4



WM327
11/16 X 2-1/4



WM356
11/16 X 2-1/4



WM366
11/16 X 2-1/4



WM376
11/16 X 2-1/4



WM442
11/16 X 2-1/4



WM351
11/16 X 2-1/2



WM361
11/16 X 2-1/2



WM371
11/16 X 2-1/2



WM472
9/16 X 2-1/2



WM445
11/16 X 3-1/4



WM444
11/16 X 3-1/2



WM379
11/16 X 3-1/2



RB-3
11/16 X 3-1/2

Urethane Louvers

Sizes & Prices can be found in the *Fypon Catalog* in Section 9E

Numbers listed are for non-venting louvers, For Venting Louvers add a "F" before the number.



HRLV24X12
HRLV28X14
HRLV32X16
HRLV36X18

HRLV42X21
HRLV48X24
HRLV60X30
HRLV72X36



HRLV36X18MTK



CLV12X24
CLV14X22
CLV16X36
CLV18X24
CLV24X48
CLV28X43
CLV36X48



EBLV12X24
EBLV18X30
EBLV22X32



DLV24X24



RLV12
RLV16
RLV18
RLV22
RLV24

RLV28
RLV30
RLV36
RLV42
RLV48



RLV16MTK
RLV18MTK
RLV24MTK
RLV30MTK
RLV32MTK
RLV40MTK



OLV18
OLV22
OLV24
OLV28
OLV30



OVL28X35K215V



OVL35X28K215



OVLV18x24V
OVLV25x37V



OVLV29X20TK
Width 29", Height 20-9/16",
2-5/32 Projection



LV8X15
LV8X24
LV8X30
LV12X18
LV12X24
LV12X30
LV12X36
LV12X40
LV14X27
LV14X30
LV14X32
LV16X24

LV16X36
LV18X24
LV18X30
LV18X36
LV18X42
LV20X28
LV24X24
LV24X30
LV24X36
LV24X48
LV30X42



LV27X17
LV32X16

Keystones

For Louver with
Brickmould



KWM180M

For Louver w/
Flat Trim



K4TF, K6TF

Recess For Lou-
ver w/Flat Trim



KP4TF, KP6TF

Urethane Louvers-& Accessories Non-Stock

Sizes & Prices can be found in the [Fypon Catalog](#)

Numbers listed are for non-venting louvers, For Venting Louvers add a “F” before the number.



Two-Piece Triangle

- TRLVLR60X25 10/12
- TRLVLR60X30 12/12
- TRLVLR108X27 6/12
- TRLVLR115X35 7-3/16/12
- TRLVLR120X30 6/12



- | | |
|-----------------|-----------------|
| TRLV36X18 12/12 | TRLV60X30 12/12 |
| TRLV42X21 12/12 | TRLV64X27 10/12 |
| TRLV48X10 5/12 | TRLV64X32 12/12 |
| TRLV48X12 6/12 | TRLV66X22 8/12 |
| TRLV48X18 9/12 | TRLV72X36 12/12 |
| TRLV48X22 11/12 | TRLV76X19 6/12 |
| TRLV48X24 12/12 | TRLV84X18 5/12 |
| TRLV60X18 7/12 | TRLV84X21 6/12 |
| TRLV60X23 9/12 | TRLV88X22 6/12 |
| TRLV60X25 10/12 | |



- PLV18X24-8/12
- PLV18X30-9/12
- PLV18X36-10/12
- PLV24X30-10/12
- PLV24X36-10/12
- PLV24X36-12/12

Custom Aluminum Louvers



Custom order gable vents are now available in **ANY SHAPE** made from the exact same material that the siding manufacturers make for their siding trim in **ANY COLOR**. We can Match any vinyl, steel, or aluminum siding, to assure the color compatibility you’ve been looking for. Each vent is made in the USA in **ANY SIZE**. These gable louvers: 1) Never need painting 2) Designed for flush mount 3) Includes J channel, recessed flange, or nailing fin, for easy installation 4) Won’t get brittle or yellow with age 5) PVC or baked-enamel finish 6) Maintenance-free 7) for use with vinyl, aluminum, steel, stucco or brick 8) Screened 9) Textured or smooth finish.

Materials & Finishes: Aluminum with PVC coating; Aluminum with baked enamel coating; Aluminum with Kynar coating; Copper-16 oz.; Painted Steel; Galvalume; Galvanized Steel. SCREEN: 9x9 vent mesh-charcoal color; 18x16 aluminum screen-charcoal colored; Galvanized, Copper, and Stainless are also available! DEPTHS: 1” (typical), 1.5”, 2”, 3”, or 4” also available

Primed & Cedar Louvers with Brickmold

All units include screens. Items with “SB” in the model designate Square Back louvers

Wood brickmold louvers are treated and primed. Additional painting needed within 3 months of installation. Louver products are not weatherproof. Certain weather conditions may force water infiltration. *These items have a molded urethane seamless one piece brickmould, blindstop. Wood not available.

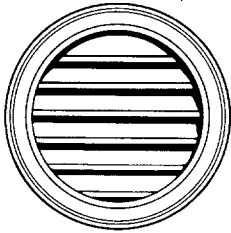

Round
(RL)

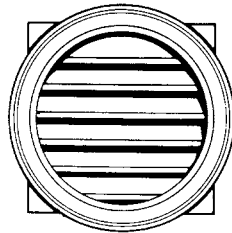

Round
(RLSB)

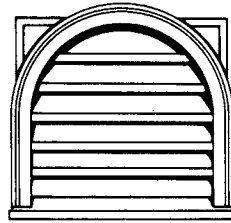

Round Top
(RTLBSB)

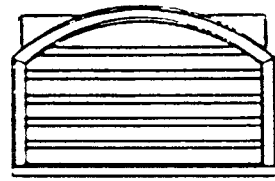

Segment Top
(STLSB)

MODEL	UNIT DIMENSION	ROUGH OPENING	VENT AREA SQ. INCHES	Prime ITEM	Cedar ITEM
RL 1-6*	1'9-3/4"	20"	62	00134	62152
RL 2-0*	2'3-3/4"	26"	114	00137	62153
RLSB 1-6	1'10-1/2"	20-1/4"	57	26418	62001
RLSB 2-0	2'3-1/2"	26"	100	26679	62002
RLSB 3-0	3'3-3/4"	38"	230	37950	62003
RLSB 4-0	4'3-3/4"	50"	438	85981	62004
RTLBSB 1616	1'9-3/4" x 1'8-1/2"	20" x 19-3/4"	65	00149	62017
RTLBSB 1626	1'9-3/4" x 2'7-7/8"	20" x 31"	119	00150	62018
STLSB 1626	1'9-3/4" x 2'7-7/8"	20" x 31"	122	43662	62019
STLSB 2616	2'9-3/4" x 1'8-1/2"	32" x 19-3/4"	108	43663	62020

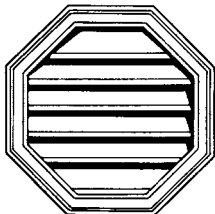

Octagon (OL)

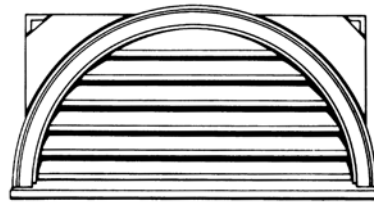

Half Round (HRLSB)



Gable Top (GTLSB)

MODEL	UNIT DIMENSION	ROUGH OPENING	VENT AREA SQ. INCHES	Prime ITEM	Cedar ITEM
OL 16	1'9-3/4" x 1'9-3/4"	20" x 20"	69	00140	62007
OL 1-11	2'2-3/4" x 2'2-3/4"	25" x 25"	115	00142	62008
OL 2-11	3'2-3/4" x 3'2-3/4"	37" x 37"	267	85937	62009
OL 1626	1'9-3/4" x 2'10-1/4"	20" x 32-3/8"	130	85938	62010
HRLSB 26*	2'10" x 1'9-1/4"	32" x 20-1/4"	92	26421	62011
HRLSB 30*	3'4" x 1'9-1/4"	38" x 20-1/4"	105	26430	62012
HRLSB 40	4'3-3/4" x 2'2-3/8"	50" x 25-1/4"	195	00146	62013
HRLSB 50	5'3-3/4" x 2'8"	62" x 31"	334	85982	62014
GTLSB 1016	1'7" x 2'9-3/4"	14" x 19-3/4"	45		62101
GTLSB 1626	2'1" x 4'0"	20" x 31"	122		62102

Flat Casing Louvers: Redwood, Cedar & Vinyl

- VENT: Std. Square Back Jamb/Frame
- VENT / RGB: Square Back Jamb/Frame with Rain-Gard Baffles (Vertical Extension to Back Side of Slats – Reduces Air Flow by 50%)
- FACADE: Non-Vent, Decorative Only, No Jamb, No R.O. needed, Closed Slats, Flush-Mounted

STD CONST. 5/8x3 1/2 Flat Casing, 5/8x2 1/2 Jamb/Frame, 5/8x3 1/2 Slats, 18x16 Fiberglass Screen, Components Clear, Knot Free, No Finger-joints, Silicone Sealed

OPTIONS-Call for Quote: Brick Mould, No Casing, Primed or Pre-Finished, 18x16 Aluminum Screen, 1/4 x 1/4 Galvanized Screen

WARRANTY: Limited-Lifetime for PVC Louvers – 2 Years for Redwood & Cedar Louvers



Shaded Items are Special Order	
Model	Flat Casing to Csg
AGL8/12-3	36x12
AGL10/12-3	36x15
AGL12/12-3	36x18
AGL8/12-4	48x16
AGL10/12-4	48x20
AGL12/12-4	48x24
AGL8/12-5	60x20
AGL10/12-5	60x25
AGL12/12-5	60x30
AGL8/12-6	72x24
AGL10/12-6	72x30
AGL12/12-6	72x36

Close-Out Redwood Gable Louvers 1500-1600

Gable designs 1500 and 1600 have been replaced by the AGL listed above. Once the stock on these items is depleted they can be quoted as custom units.



Clear redwood. **2-PIECE** louvers are furnished in two matching sections with 1X3 Flat casing, mullion casing, full sill, Profiled Slat edge, Silicone Sealing with 18x16 Fiberglass Mesh Screen. Pitched Inside Jambs. Z-Slat with Rain Baffle provides maximum protection against driving, blowing rains. Because the baffles can reduce air flow by up to 50%, louver size should be considered.

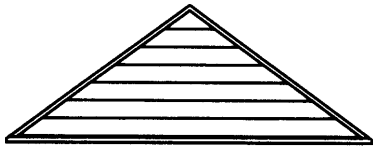

Clear redwood. **ECONOMY** louvers with NO exterior casing nor sill, Profiled Slat edge, Silicone Sealing with 18x16 Fiberglass Mesh Screen. Pitched Inside Jambs. Z-slat with Rain Baffle provides maximum protection against driving, blowing rains. Because the baffles can reduce air flow by up to 50%, louver size should be considered.

#1500	Rough Opening
4/12-5	6'1-1/2"x 1'0-1/4"
5/12-5	5'9-5/8"x 1'2-1/2"
5/12-8	8'9-5/8"x 1'10"
8/12-4	4'6-3/4"x 1'6-1/4"
9/12-5	5'6-3/8"x 2'0-3/8"
9/12-6	6'6-3/8"x 2'5-3/8"
10/12-4	4'5-3/4"x 1'10-3/8"
12/12-4	4'5"x 2'2-1/2"
#1600	Rough Opening
5/12-4	4'4"x 0'11-1/4"
6/12-6	6'3-1/2"x 1'7-1/4"
8/12-6	6/2-3/4"x 2'1-1/4"
9/12-5	5'2-1/2"x 1'11-3/4"
9/12-6	6'2-1/2"x 2'4-1/4"
12/12-5	5'3"x 2'7-1/2"
12/12-6	6'3"x 3'1-1/2"

Flat Casing Louvers: Redwood, Cedar & Vinyl

- VENT: Std. Square Back Jamb/Frame
- VENT / RGB: Square Back Jamb/Frame with Rain-Gard Baffles (Vertical Extension to Back Side of Slats – Reduces Air Flow by 50%)
- FACADE: Non-Vent, Decorative Only, No Jamb, No R.O. needed, Closed Slats, Flush-Mounted

STD CONST. 5/8x3 1/2 Flat Casing, 5/8x2 1/2 Jamb/Frame, 5/8x3 1/2 Slats, 18x16 Fiberglass Screen, Components Clear, Knot Free, No Finger-joints, Silicone Sealed

OPTIONS-Call for Quote: Brick Mould, No Casing, Primed or Pre-Finished, Same Shape Jamb, 18x16 Aluminum Screen, 1/4 x 1/4 Galvanized Screen

WARRANTY: Limited-Lifetime for PVC Louvers – 2 Years for Redwood & Cedar Louvers

Round



Half Round



Octagon



Spring-line



ROUND	Rough Opening	Flat Csg to Csg
RL15	10 1/2" x 10 1/2"	15" diam
RL18	13 1/2" x 13 1/2"	18" diam
RL24	19 1/2" x 19 1/2"	24" diam
RL26	21 1/2" x 21 1/2"	28" diam
RL28	23 1/2" x 23 1/2"	28" diam
RL30	25 1/2" x 25 1/2"	30" diam
RL32	27 1/2" x 27 1/2"	32" diam
RL36	31 1/2" x 31 1/2"	36" diam
HALF ROUND	Rough Opening	Flat Csg to Csg
HRL2414	19 1/2" x 9 1/2"	24x14
HRL3017	25 1/2" x 12 1/2"	30x17
HRL3218	27 1/2" x 13 1/2"	32x18
HRL3620	31 1/2" x 15 1/2"	36x20
OCTAGON	Rough Opening	Flat Csg to Csg
OCTL15	10 1/2" x 10 1/2"	15x15
OCTL18	13 1/2" x 13 1/2"	18x18
OCTL22	17 1/2" x 17 1/2"	24x24
OCTL24	19 1/2" x 19 1/2"	24x24
OCTL26	21 1/2" x 21 1/2"	26x26
OCTL28	23 1/2" x 23 1/2"	28x28
OCTL30	25 1/2" x 25 1/2"	30x30
OCTL32	27 1/2" x 27 1/2"	32x32
OCTL36	31 1/2" x 31 1/2"	36x36
SpringLine	Rough Opening	Flat Csg to Csg
SPGL1228	7 1/2" x 23 1/2"	12x30
SPGL1430	9 1/2" x 25 1/2"	14x30
SPGL1628	11 1/2" x 23 1/2"	18x30
SPGL1830	13 1/2" x 25 1/2"	18x30
SPGL1836	13 1/2" x 31 1/2"	18x36
SPGL2436	19 1/2" x 31 1/2"	24x36

Rectangle



Model	Rough Opening	Flat Casing to Csg
RECTL1224	7 1/2" x 19 1/2"	12x24
RECTL1230	7 1/2" x 25 1/2"	12x30
RECTL1236	7 1/2" x 31 1/2"	12x36
RECTL1624	11 1/2" x 19 1/2"	16x24
RECTL1630	11 1/2" x 25 1/2"	16x30
RECTL1636	11 1/2" x 31 1/2"	16x36
RECTL1824	13 1/2" x 19 1/2"	18x24
RECTL1830	13 1/2" x 25 1/2"	18x30
RECTL1836	13 1/2" x 31 1/2"	18x36
RECTL2424	19 1/2" x 19 1/2"	24x24
RECTL2430	19 1/2" x 25 1/2"	24x30
RECTL2436	19 1/2" x 31 1/2"	24x36

Cathedral



Cathedral	Rough Opening	Flat Csg to Csg
CATHL-1228	7 1/2" x 23 1/2"	12x28
CATHL-1430	9 1/2" x 25 1/2"	14x30
CATHL-1628	11 1/2" x 23 1/2"	16x28
CATHL-1830	13 1/2" x 25 1/2"	18x30
CATHL-1836	13 1/2" x 31 1/2"	18x36
CATHL-2436	19 1/2" x 31 1/2"	24x36
+CATH2437BM	22" x 36 1/2"	stock BM
Oval	Rough Opening	Flat Csg to Csg
OVAL1628	11 1/2" x 23 1/2"	16x28
OVAL2816	23 1/2" x 11 1/2"	28x16
OVAL2436	19 1/2" x 31 1/2"	24x36
OVAL3624	31 1/2" x 19 1/2"	36x24
Quarter Rnd	Rough Opening	Flat Csg to Csg
QTRL18	13 1/2" x 13 1/2"	18x18
QTRL24	19 1/2" x 19 1/2"	24x24
QTRL30	25 1/2" x 25 1/2"	30x30

Oval



Qtr Round



Qtr Round pictured with custom BrickMold

B&B Wood Products inc.

Distributed by:

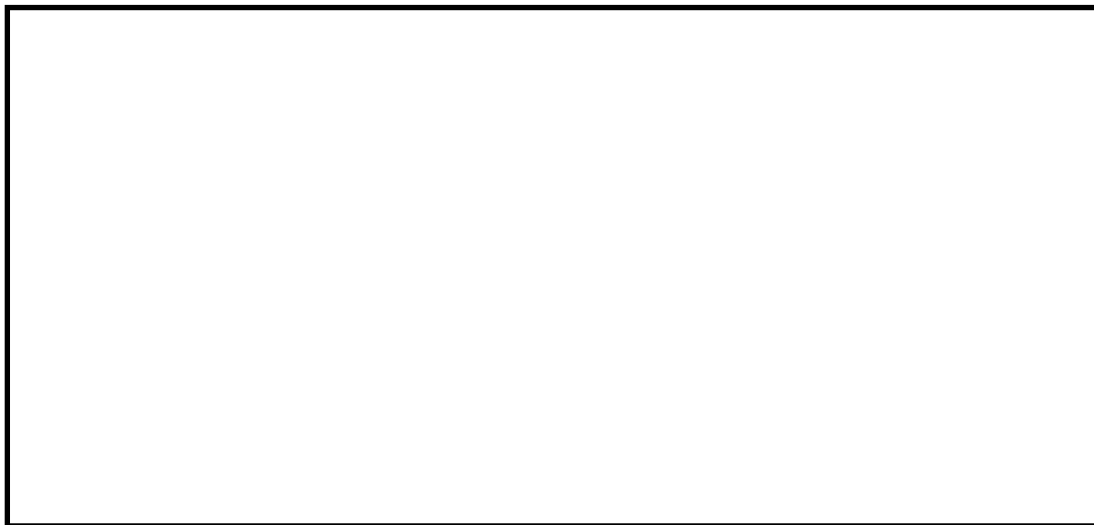

Price subject to change without notice.

© 2021 B&B Wood Products, Inc All rights reserved